











































ACTION®

Insert and Power Drive Bits



Contents

Insert and Power Bits

01.C6	Insert Bits:  1/4" = 6.3mm Hex Shank	2-3
	        	
02.P6	Power Bits:  1/4" = 6.3mm Hex Shank	4-7
	     	
03.D6	Double end Power Bits:  1/4" = 6.3mm Hex Shank	8
		
04.C8	Insert Bits:  5/16" = 8.0mm Hex Shank	9-10
	     	
05.E4	Bits for precision screws:  \varnothing 4mm Shank Drive	11
	   	
06.E5	Bits for precision screws:  \varnothing 5mm Shank Drive	12
	   	
07.P5	Bits for precision screws:  5mm Hex Drive	13
	  	
08.Bit Holders	For Insert Bits	14-15
09.Ratchet	Reversible Ratchet for 1/4" Hex Insert	16

-  **Phillips**  **Pozidriv**  **Slotted**
-  **Hexagon**  **TX-Star**  **Square**
-  **Tri-Wing**  **Torq-Set**  **XZN-Triple Square**
-  **TX-Star with Tamper Proof**
-  **Spanner**

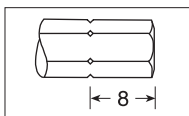

DIN 3126-C6.3

Insert Bits

1/4" = 6.3mm Hex Shank

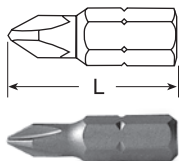

C61 Phillips

Order No.		L	
		mm	inch
C6100000	PH.0	25	1
C6100001	PH.1	25	1
C6100002	PH.2	25	1
C6100003	PH.3	25	1

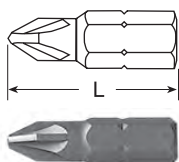

C62 Pozidriv

Order No.		L	
		mm	inch
C6200000	PZ.0	25	1
C6200001	PZ.1	25	1
C6200002	PZ.2	25	1
C6200003	PZ.3	25	1

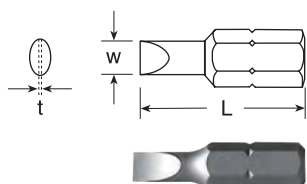

C63 Slotted

Order No.	t x w		L	
	mm	inch	mm	inch
C6300530	0.5x3.0	0.020x0.118	25	1
C6300540	0.5x4.0	0.020x0.158	25	1
C6300645	0.6x4.5	0.024x0.178	25	1
C6300855	0.8x5.5	0.032x0.217	25	1
C6301055	1.0x5.5	0.040x0.217	25	1
C6301265	1.2x6.5	0.048x0.256	25	1

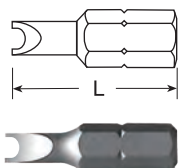

C631 Spanner

Order No.	Size	L	
		mm	inch
C6310004	4	25	1
C6310006	6	25	1
C6310008	8	25	1
C6310010	10	25	1

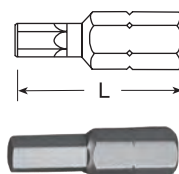

C64 Hexagon

Order No.	Size	L	
	mm	mm	inch
C6400020	2	25	1
C6400025	2.5	25	1
C6400030	3	25	1
C6400040	4	25	1
C6400050	5	25	1
C6400060	6	25	1
C6400080	8	25	1

Order No.	inch	mm	inch
C6410005	5/64"	25	1
C6410006	3/32"	25	1
C6410008	1/8"	25	1
C6410010	5/32"	25	1
C6410012	3/16"	25	1
C6410016	1/4"	25	1

☆ Pozidriv is a registered trademark of Phillips Screw Company.

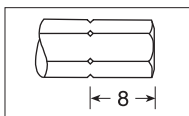

DIN 3126-C6.3

Insert Bits

 1/4" = 6.3mm Hex Shank



C65 TX-Star

Order No.	Size	L	
		mm	inch
C6500005	T-5	25	1
C6500006	T-6	25	1
C6500007	T-7	25	1
C6500008	T-8	25	1
C6500009	T-9	25	1
C6500010	T-10	25	1
C6500015	T-15	25	1
C6500020	T-20	25	1
C6500025	T-25	25	1
C6500027	T-27	25	1
C6500030	T-30	25	1
C6500040	T-40	25	1
C6500045	T-45	25	1
C6500050	T-50	25	1

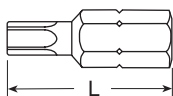

C66 TX-Star with Tamper Proof

Order No.	Size	L	
		mm	inch
C6600005	T-5	25	1
C6600006	T-6	25	1
C6600007	T-7	25	1
C6600008	T-8	25	1
C6600009	T-9	25	1
C6600010	T-10	25	1
C6600015	T-15	25	1
C6600020	T-20	25	1
C6600025	T-25	25	1
C6600027	T-27	25	1
C6600030	T-30	25	1
C6600040	T-40	25	1

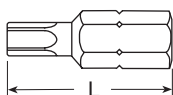

C67 Square

☆ Torx® is a trademark of Textron.

Order No.	Size	L	
		mm	inch
C6700000	S-0	25	1
C6700001	S-1	25	1
C6700002	S-2	25	1
C6700003	S-3	25	1

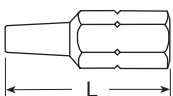

C68 Tri-Wing

Order No.	Size	L	
		mm	inch
C6800000	0	25	1
C6800001	1	25	1
C6800002	2	25	1
C6800003	3	25	1

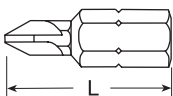

C69 Torq-Set

Order No.	Size	L	
		mm	inch
C6900004	4	25	1
C6900006	6	25	1
C6900008	8	25	1
C6900010	10	25	1

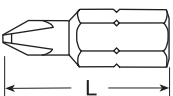

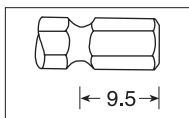

DIN 3126-E6.3

Power Bits

1/4" = 6.3mm Hex Shank



P61 Phillips

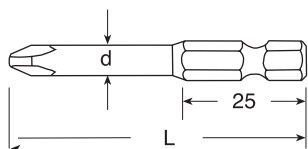

P62 Pozidriv

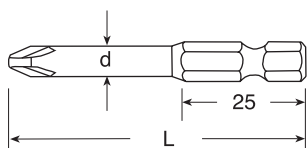

P63 Slotted

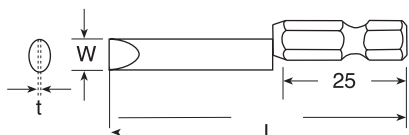

Order No.	Size	L		d	
		mm	inch	mm	inch
P6100500	PH.0	50	2	2.5	0.098
P6100501	PH.1	50	2	5	0.197
P6100502	PH.2	50	2	6	0.236
P6100503	PH.3	50	2	6	0.236
P6100750	PH.0	75	3	2.5	0.098
P6100751	PH.1	75	3	5	0.197
P6100752	PH.2	75	3	6	0.236
P6100753	PH.3	75	3	6	0.236
P6101001	PH.1	100	4	5	0.197
P6101002	PH.2	100	4	6	0.236
P6101003	PH.3	100	4	6	0.236
P6101501	PH.1	150	6	5	0.197
P6101502	PH.2	150	6	6	0.236
P6101503	PH.3	150	6	6	0.236

Order No.	Size	L		d	
		mm	inch	mm	inch
P6200501	PZ.1	50	2	5	0.197
P6200502	PZ.2	50	2	6	0.236
P6200503	PZ.3	50	2	6	0.236
P6200751	PZ.1	75	3	5	0.197
P6200752	PZ.2	75	3	6	0.236
P6200753	PZ.3	75	3	6	0.236
P6201001	PZ.1	100	4	5	0.197
P6201002	PZ.2	100	4	6	0.236
P6201003	PZ.3	100	4	6	0.236
P6201501	PZ.1	150	6	5	0.197
P6201502	PZ.2	150	6	6	0.236
P6201503	PZ.3	150	6	6	0.236

Order No.	t x w		L	
	mm	inch	mm	inch
P6300540	0.5x4.0	0.020x0.158	50	2
P6300645	0.6x4.5	0.024x0.178	50	2
P6300855	0.8x5.5	0.032x0.217	50	2
P6301055	1.0x5.5	0.040x0.217	50	2
P6301265	1.2x6.5	0.048x0.250	50	2
P6310645	0.6x4.5	0.024x0.178	75	3
P6310855	0.8x5.5	0.032x0.217	75	3
P6311060	1.0x6.0	0.040x0.237	75	3
P6320645	0.6x4.5	0.024x0.178	100	4
P6320855	0.8x5.5	0.032x0.217	100	4
P6321060	1.0x6.0	0.040x0.237	100	4
P6330645	0.6x4.5	0.024x0.178	150	6
P6330855	0.8x5.5	0.032x0.217	150	6
P6331060	1.0x6.0	0.040x0.237	150	6

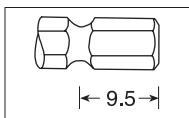

DIN 3126-E6.3

Power Bits

1/4" = 6.3mm Hex Shank

P64 Hexagon

Order No.	H	L		d	
		mm	inch	mm	inch
P6400502	2	50	2	5	0.197
P6400525	2.5	50	2	5	0.197
P6400503	3	50	2	5	0.197
P6400504	4	50	2	5	0.197
P6400505	5	50	2	6	0.236
P6400506	6	50	2	-	-
P6400507	7	50	2	-	-
P6400508	8	50	2	-	-
P6400752	2	75	3	5	0.197
P6400725	2.5	75	3	5	0.197
P6400753	3	75	3	5	0.197
P6400754	4	75	3	5	0.197
P6400755	5	75	3	6	0.236
P6400756	6	75	3	-	-
P6400758	8	75	3	-	-
P6401003	3	100	4	5	0.197
P6401004	4	100	4	5	0.197
P6401005	5	100	4	6	0.236
P6401006	6	100	4	-	-
P6401008	8	100	4	-	-
P6401503	3	150	6	5	0.197
P6401504	4	150	6	5	0.197
P6401505	5	150	6	6	0.236
P6401506	6	150	6	-	-

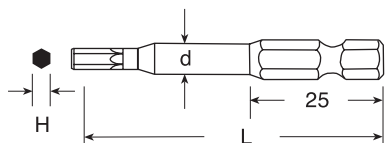

Order No.	H	L		d	
		mm	inch	mm	inch
P6410503	1/8"	50	2	5	0.197
P6410504	5/32"	50	2	5	0.197
P6410505	3/16"	50	2	6	0.236
P6410506	1/4"	50	2	-	-
P6410753	1/8"	75	3	5	0.197
P6410754	5/32"	75	3	5	0.197
P6410755	3/16"	75	3	6	0.236
P6410756	1/4"	75	3	-	-
P6411003	1/8"	100	4	5	0.197
P6411004	5/32"	100	4	5	0.197
P6411005	3/16"	100	4	6	0.236
P6411006	1/4"	100	4	-	-
P6411503	1/8"	150	6	5	0.197
P6411504	5/32"	150	6	5	0.197
P6411505	3/16"	150	6	6	0.236
P6411506	1/4"	150	6	-	-

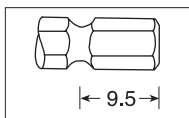

DIN 3126-E6.3

Power Bits

1/4" = 6.3mm Hex Shank



P65 TX-Star

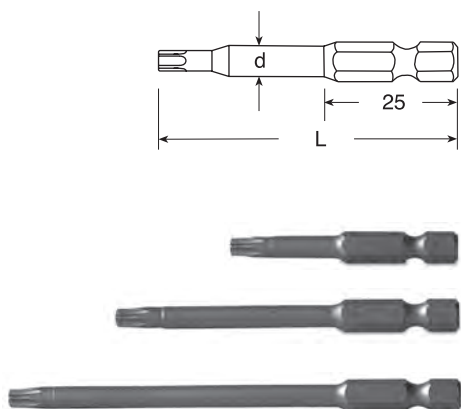

Order No.	Size	L		d	
		mm	inch	mm	inch
P6505008	T-8	50	2	4	0.158
P6505010	T-10	50	2	4	0.158
P6505015	T-15	50	2	4	0.158
P6505020	T-20	50	2	4.5	0.178
P6505025	T-25	50	2	5	0.197
P6505027	T-27	50	2	6	0.236
P6505030	T-30	50	2	6	0.236
P6505040	T-40	50	2	-	-
P6505045	T-45	50	2	-	-
P6505050	T-50	50	2	-	-
P6507508	T-8	75	3	4	0.158
P6507510	T-10	75	3	4	0.158
P6507515	T-15	75	3	4.5	0.178
P6507520	T-20	75	3	4.5	0.178
P6507525	T-25	75	3	5	0.197
P6507527	T-27	75	3	6	0.236
P6507530	T-30	75	3	6	0.236
P6507540	T-40	75	3	-	-
P6507545	T-45	75	3	-	-
P6507550	T-50	75	3	-	-
P6510008	T-8	100	4	4	0.158
P6510010	T-10	100	4	4	0.158
P6510015	T-15	100	4	4.5	0.178
P6510020	T-20	100	4	4.5	0.178
P6510025	T-25	100	4	5	0.197
P6510027	T-27	100	4	6	0.236
P6510030	T-30	100	4	6	0.236
P6510040	T-40	100	4	-	-
P6510045	T-45	100	4	-	-
P6510050	T-50	100	4	-	-
P6515008	T-8	150	6	4	0.158
P6515010	T-10	150	6	4	0.158
P6515015	T-15	150	6	4.5	0.178
P6515020	T-20	150	6	4.5	0.178
P6515025	T-25	150	6	5	0.197
P6515027	T-27	150	6	6	0.236
P6515030	T-30	150	6	6	0.236
P6515040	T-40	150	6	-	-
P6515045	T-45	150	6	-	-
P6515050	T-50	150	6	-	-

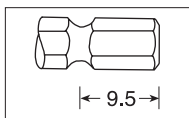

DIN 3126-E6.3

Power Bits

1/4" = 6.3mm Hex Shank



P66 TX-Star with Tamper Proof

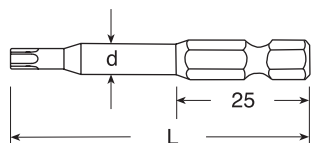

Order No.	Size	L		d	
		mm	inch	mm	inch
P6605008	T-8	50	2	4	0.158
P6605010	T-10	50	2	4	0.158
P6605015	T-15	50	2	4	0.158
P6605020	T-20	50	2	4.5	0.178
P6605025	T-25	50	2	5	0.197
P6605027	T-27	50	2	6	0.236
P6605030	T-30	50	2	6	0.236
P6605040	T-40	50	2	-	-
P6605045	T-45	50	2	-	-
P6605050	T-50	50	2	-	-
P6607508	T-8	75	3	4	0.158
P6607510	T-10	75	3	4	0.158
P6607515	T-15	75	3	4.5	0.178
P6607520	T-20	75	3	4.5	0.178
P6607525	T-25	75	3	5	0.197
P6607527	T-27	75	3	6	0.236
P6607530	T-30	75	3	6	0.236
P6610008	T-8	100	4	4	0.158
P6610010	T-10	100	4	4	0.158
P6610015	T-15	100	4	4.5	0.178
P6610020	T-20	100	4	4.5	0.178
P6610025	T-25	100	4	5	0.197
P6610027	T-27	100	4	6	0.236
P6610030	T-30	100	4	6	0.236
P6615008	T-8	150	6	4	0.158
P6615010	T-10	150	6	4	0.158
P6615015	T-15	150	6	4.5	0.178
P6615020	T-20	150	6	4.5	0.178
P6615025	T-25	150	6	5	0.197
P6615027	T-27	150	6	6	0.236
P6615030	T-30	150	6	6	0.236

☆ Torx® is a trademark of Textron.

Double end Power Bits

1/4" = 6.3mm Hex Shank



D611 Phillips Shank Length 9.5mm



Order No.	Size	L	
		mm	inch
D6110501	PH.1	50	2
D6110751	PH.1	75	3
D6111001	PH.1	100	4

D6110502	PH.2	50	2
D6110752	PH.2	75	3
D6111002	PH.2	100	4
D6111502	PH.2	150	6

D6110503	PH.3	50	2
D6110753	PH.3	75	3
D6111003	PH.3	100	4

D611 Phillips Shank Length 13mm

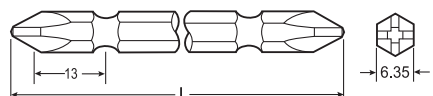

Order No.	Size	L	
		mm	inch
D6100451	PH.1	45	1.77
D6100651	PH.1	65	2.60
D6101101	PH.1	110	4.33

D6100452	PH.2	45	1.77
D6100652	PH.2	65	2.60
D6101102	PH.2	110	4.33
D6101502	PH.2	150	6

D6100453	PH.3	45	1.77
D6100653	PH.3	65	2.60
D6101103	PH.3	110	4.33

* If with magnet item no. add. M
Exp.D6100451M

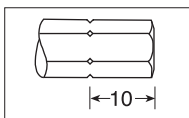

DIN 3126-C8

Insert Bits

5/16" = 8.0mm Hex Shank

+ C81 Phillips

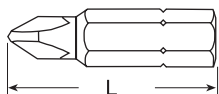

Order No.	Size	L	
		mm	inch
C8100001	PH.1	35	1.38
C8100002	PH.2	35	1.38
C8100003	PH.3	35	1.38
C8100004	PH.4	35	1.38
C8110001	PH.1	80	3.15
C8110002	PH.2	80	3.15
C8110003	PH.3	80	3.15
C8110004	PH.4	80	3.15

* C82 Pozidriv

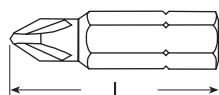

Order No.	Size	L	
		mm	inch
C8200001	PZ.1	35	1.38
C8200002	PZ.2	35	1.38
C8200003	PZ.3	35	1.38
C8200004	PZ.4	35	1.38

o C83 Slotted

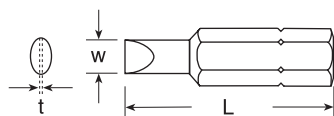

Order No.	t x w		L	
	mm	inch	mm	inch
C8300855	0.8x5.5	0.032x0.217	35	1.38
C8301055	1.0x5.5	0.040x0.217	35	1.38
C8301265	1.2x6.5	0.048x0.256	35	1.38
C8301680	1.6x8.0	0.063x0.315	35	1.38
C8310855	0.8x5.5	0.032x0.217	80	3.15
C8311055	1.0x5.5	0.040x0.217	80	3.15
C8311265	1.2x6.5	0.048x0.256	80	3.15
C8311680	1.6x8.0	0.063x0.315	80	3.15

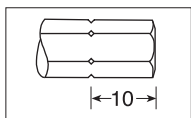

DIN 3126-C8

Insert Bits

5/16" = 8.0mm Hex Shank

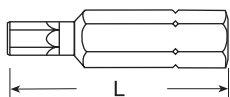

C84 Hexagon

Order No.	Size		L	
	mm	mm	mm	inch
C8400003	3	35	35	1.38
C8400004	4	35	35	1.38
C8400005	5	35	35	1.38
C8400006	6	35	35	1.38
C8400007	7	35	35	1.38
C8400008	8	35	35	1.38
C8400009	9	35	35	1.38
C8400010	10	35	35	1.38
C8400011	11	35	35	1.38
C8400012	12	35	35	1.38

Order No.	Size		L	
	inch	mm	mm	inch
C8401008	1/8"	35	35	1.38
C8401010	5/32"	35	35	1.38
C8401012	3/16"	35	35	1.38
C8401016	1/4"	35	35	1.38
C8401020	5/16"	35	35	1.38
C8401024	3/8"	35	35	1.38
C8401028	7/16"	35	35	1.38
C8401032	1/2"	35	35	1.38



C85 TX-Star

Order No.	Size	L	
		mm	inch
C8500010	T-10	35	1.38
C8500015	T-15	35	1.38
C8500020	T-20	35	1.38
C8500025	T-25	35	1.38
C8500027	T-27	35	1.38
C8500030	T-30	35	1.38
C8500040	T-40	35	1.38
C8500045	T-45	35	1.38
C8500050	T-50	35	1.38
C8500055	T-55	35	1.38
C8500060	T-60	35	1.38

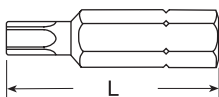

C86 XZN-Triple Square

Order No.	Size	L	
		mm	inch
C8600004	M-4	35	1.38
C8600005	M-5	35	1.38
C8600006	M-6	35	1.38
C8600008	M-8	35	1.38
C8600009	M-9	35	1.38
C8600010	M-10	35	1.38
C8600012	M-12	35	1.38

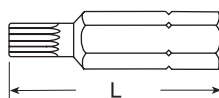

☆ Torx® is a trademark of Textron.

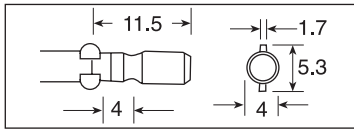

Bits for precision screws

4mm Shank Drive

E41 Phillips

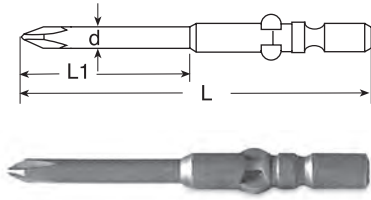

Order No.	Size	L mm	d mm	L1 mm
E4100150	PH.00	60	1.5	20
E4100250	PH.0	60	2.5	20
E4100301	PH.1	60	3.0	20
E4100402	PH.2	60	4.0	-

E43 Slotted

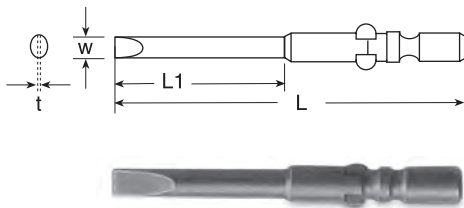

Order No.	w x t mm	L mm	L1 mm
E4302004	2.0x0.4	40	20
E4302504	2.5x0.4	40	20
E4303004	3.0x0.4	40	20
E4304006	4.0x0.6	40	-

E45 TX-Star

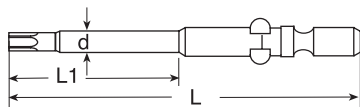

Order No.	Size	L mm	d mm	L1 mm
E4500005	T-5	60	2.0	20
E4500006	T-6	60	2.0	20
E4500007	T-7	60	2.0	20
E4500008	T-8	60	4.0	-
E4500009	T-9	60	4.0	-
E4500010	T-10	60	4.0	-
E4500015	T-15	60	4.0	-



E45 TX-Star with Tamper Proof

Order No.	Size	L mm	d mm	L1 mm
E4500108	T-8H	60	4.0	-
E4500109	T-9H	60	4.0	-
E4500110	T-10H	60	4.0	-
E4500115	T-15H	60	4.0	-

☆ Torx® is a trademark of Textron.

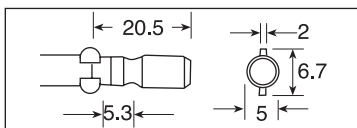

Bits for precision screws

5mm Shank Drive

+ E51 Phillips

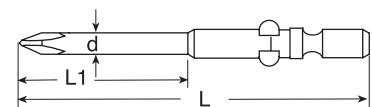

Order No.	Size	L mm	d mm	L1 mm
E5100200	PH.00	60	2.0	20
E5100250	PH.0	60	2.5	25
E5100301	PH.1	60	3.0	25
E5100502	PH.2	60	5.0	-

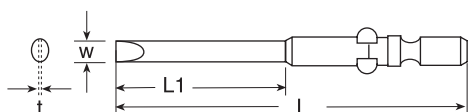

○ E53 Slotted

Order No.	w x t mm	L mm	L1 mm
E5302003	2.0x0.3	60	25
E5302504	2.5x0.4	60	25
E5303004	3.0x0.4	60	25
E5304006	4.0x0.6	60	25
E5305075	5.0x0.75	60	-

★ E55 TX-Star

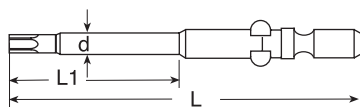

Order No.	Size	L mm	d mm	L1 mm
E5500005	T-5	60	2.0	20
E5500006	T-6	60	2.0	20
E5500007	T-7	60	2.0	20
E5500008	T-8	60	3.0	20
E5500009	T-9	60	3.0	20
E5500010	T-10	60	3.5	20
E5500015	T-15	60	5.0	-

★ E55 TX-Star with Tamper Proof

Order No.	Size	L mm	d mm	L1 mm
E5500108	T-8H	60	3.0	20
E5500109	T-9H	60	3.0	20
E5500110	T-10H	60	3.5	20
E5500115	T-15H	60	5.0	-

★ Torx® is a trademark of Textron.

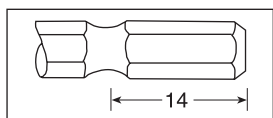

Bits for precision screws

5mm Hex Drive

P51 Phillips

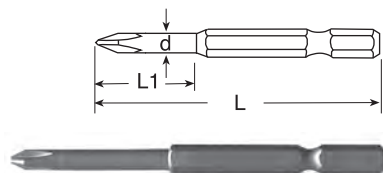

Order No.	Size	L mm	d mm	L1 mm
P5100000	PH.0	70	2.5	30
P5100001	PH.1	70	3.0	30
P5100002	PH.2	70	4.0	30

P54 Hexagon

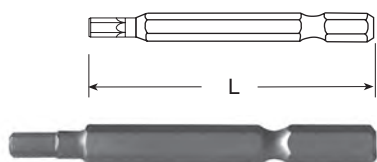

Order No.	Size	L mm
P5400020	2	70
P5400025	2.5	70
P5400030	3	70
P5400040	4	70
P5400050	5	70

P55 TX-Star

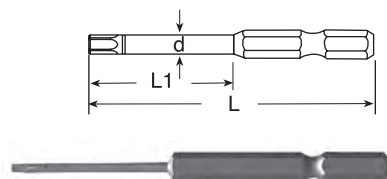

Order No.	Size	L mm	d mm	L1 mm
P5500006	T-6	70	2.0	30
P5500007	T-7	70	2.0	30
P5500008	T-8	70	2.5	30
P5500009	T-9	70	2.5	30
P5500010	T-10	70	3.0	30
P5500015	T-15	70	3.5	30
P5500020	T-20	70	5.0	30
P5500025	T-25	70	5.0	30
P5500027	T-27	70	5.0	30



☆ Torx® is a trademark of Textron.



1/4" Hex Drive for 1/4" Hex Insert With Magnetic & Lock Ring

Bit Holder





Order No.			Length
	inch	inch	mm
MRB11-050	1/4"	1/4"	50
MRB11-075	1/4"	1/4"	75
MRB11-100	1/4"	1/4"	100
MRB11-150	1/4"	1/4"	150
MRB11-200	1/4"	1/4"	200



Quick-Release Bit Holder



1/4" Hex Drive for 1/4" Hex Insert With Magnetic



Order No.			Length
	inch	inch	mm
BH1-0860	1/4"	1/4"	60
BH1-0875	1/4"	1/4"	75



Quick-Release Bit Holder



For 1/4" Hex Insert DIN3126 C6.3



Order No.			D2	L
	inch	inch	mm	mm
69121B08	3/8"	1/4"	19	33
69121B10	3/8"	5/16"	17	37
69122B08	1/2"	1/4"	25	41
69122B10	1/2"	5/16"	25	41



Quick-Release Chuck



For 1/4" Hex Power Bits DIN3126 E6.3

Order No.			D2	L
	inch	inch	mm	mm
69111A08	3/8"	1/4"	19	45
69112A08	1/2"	1/4"	22	54





Double End Bit Through Sockets

With two magnets at the 6-point opening
For use with DIN 3126-E6.3

1/4" = 6.3mm Hex Shank Double end Power Bits

	Drive	Ø	Ø	D2	D1	L1	L2	L
Order No.	inch	mm	mm	mm	mm	mm	mm	mm
69160008	1/4"	10	8	15.0	13.0	6	5	70
69160010	1/4"	12	10	18.5	15.5	8	8	80

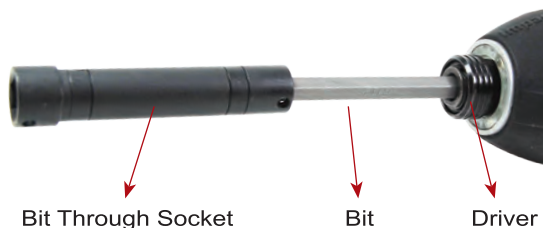
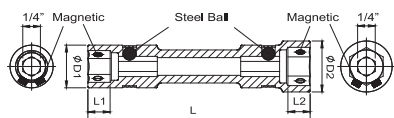

Bit Through Sockets

With Tube type magnetic
For use with DIN 3126-E6.3

1/4" = 6.3mm Hex Shank Double end Power Bits

	Drive	Ø	D2	D1	L1	L
Order No.	inch	mm	mm	mm	mm	mm
6916A010	1/4"	10	15.5	11	5	36
6916A012	1/4"	12	18.5	11	5	36

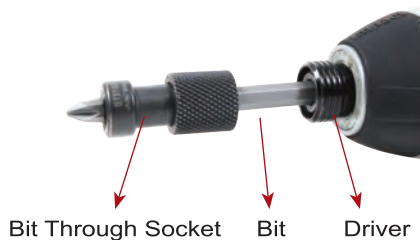
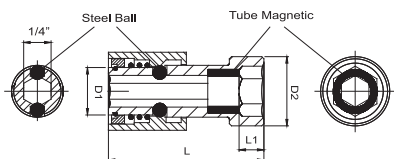

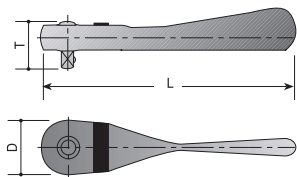

Model#AJ-100

**Stubby Wing Reversible Ratchet
Housing: Stainless steel.**

1/4" Dr., Reversible Ratchet



Order No.	■	Teeth	L mm	D mm	T mm
AJ-100.1	1/4"	72	100	22	18

1/4"-6.30 Hex. Insert Bit Reversible Ratchet



Order No.	⬡	Teeth	L mm	D mm	T mm
AJ-100.2	1/4"	72	100	22	12

10mm 12-Point Ring-End Reversible Ratchet



Order No.	⊙	Teeth	L mm	D mm	T mm
AJ-100	10mm	72	100	22	8

AJ-100.3 Reversible Ratchet & Adapter Set.

Contents:

1pc-AJ-100

1pc-1/4" Dr., Quick Release socket Adapter

1pc-1/4" Hex. Bit Adaptor for 1/4" Insert bits.



Model#AJ-101

**Mini Reversible Ratchet
Housing: Stainless steel.**

1/4" Dr., Reversible Ratchet



Order No.	■	Teeth	L mm	D mm	T mm
AJ-101.1	1/4"	72	90	22	18

1/4"-6.30 Hex. Insert Bit Reversible Ratchet



Order No.	⬡	Teeth	L mm	D mm	T mm
AJ-101	1/4"	72	90	22	12





BTfixo Comércio de Ferramentas Ltda

Rua Jacob Cemim, 68 - sala 02, Bairro N.S Fátima,

CEP: 95.041-230, Caxias do Sul - RS

Fone / Fax: (54) 3021.4119

E-mail: vendas@btfixo.com.br

Site: www.btfixo.com.br

No.CN41.ACB-1701

JUN.17.1000